

new@forster

18 mm Ansicht: Innenanwendungen mit schmalsten Profilsystemen
Face vue 18mm: utilisation intérieure avec les plus fins des profilés
18 mm View: Interior applications with the slimmest profile systems



Forster presto XS – flächenbündige oder flächenversetzte Türen und Verglasungen

- Schmalste Ansichten
- Grosse Glasflächen
- Geeignet für Neu- und Sanierungsbauten
- Neue Systembeschläge (Drücker, Schlösser, usw.)

Forster presto XS – portes et vitrages affleurants ou décalés

- Faces vues les plus étroites
- Grandes surfaces vitrées
- Convient aux bâtiments neufs et rénovés
- Nouveaux équipements du système (poignées, serrures, etc.)

Forster presto XS – flush or recessed doors and glazing

- Slim sightlines
- Large glass surfaces
- Suitable for new and refurbished buildings
- New system fittings (handles, locks, etc.)

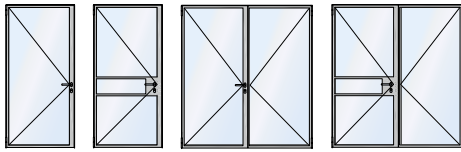
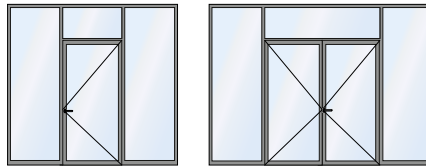
Technische Merkmale**Caractéristiques techniques****Technical characteristics****Bauarten****Variantes de construction****Construction variations**

- Tür: flächenbündig und flächenversetzt
- Verglasung

- Porte: affleurant et décalé
- Vitrages

- Door: flush and recessed
- Glazing

Abmessungen

- 1-flüglig: lichter Durchgang
max. 1200 × 2400 mm (B × H)
- 2-flüglig: lichter Durchgang
max. 2400 × 2400 mm (B × H)

Dimensions

- 1 vantail: passage libre
max. 1200 mm × 2400 (l × h)
- 2 vantaux: passage libre
max. 2400 × 2400 mm (l × h)

Dimensions

- 1 leaf: inside width
max. 1200 × 2400 mm (w × h)
- 2 leaves: inside width
max. 2400 × 2400 mm (w × h)

Merkmale

- Schmalste Ansichten
- Grosse Glasflächen
- Geeignet für Neu- und Sanierungsbauten

Caractéristiques

- Faces vues les plus étroites
- Grandes surfaces vitrées
- Convient aux bâtiments neufs et rénovés

Features

- Slim sightlines
- Large glass surfaces
- Suitable for new and refurbished buildings

Ausgangsmaterial

- 100 % Stahl, 100% recyklierbar
- Ökologisch und nachhaltig
- Kaltgewalztes Stahlband für bessere Oberflächen

Matériel de base

- 100 % acier, 100 % recyclable
- Ecologique et résistant
- Feuillard laminé à froid pour de meilleures surfaces

Basic material

- 100 % steel, 100% recyclable
- Ecological and sustainable
- Cold-rolled steel strip for better surfaces

Profilmasse

- Bautiefe 50 / 57 mm
- Wandstärke 1.5 mm
- Glasfalz 15 mm
- Profilsichtsbreite 18 mm

Dimensions du profil

- Profondeur des profilés 50 / 57 mm
- Epaisseur de la paroi 1,5 mm
- Prise en feuillure 15 mm
- Largeur de la face du profil 18 mm

Profile dimensions

- construction depth 50 / 57 mm
- wall thickness 1.5 mm
- Glass rebate 15 mm
- Profile face width 18 mm

Schloss und Beschlag

- Neue schmale systemabgestimmte Beschläge verfügbar
- Formschöne Edelstahl und Aluminiumgriffgarnituren, schlanke Rollenanschweissbänder
- Anwendung von presto Standardbeschlägen möglich

Serrure et accessoires

- Nouveaux ferrements fins, adaptés au système disponibles
- Élégantes poignées en acier inoxydable et en aluminium, paumelles à souder fines avec roulement à billes
- Utilisation possible des ferrements presto standard

Lock and fittings

- New narrow system-coordinated fittings available
- Elegant stainless steel and aluminium handle sets, slim roller weld-on straps
- Application of presto standard fittings possible

Verarbeitung

- Äusserst wirtschaftliche Fertigung ohne Sondereinrichtung

Mise en oeuvre

- Mise en oeuvre extrêmement économique, sans équipement spécial

Processing

- Extremely economical production without special equipment

**Profile
Stahl**

**Profils
Acier**

**Profiles
Steel**

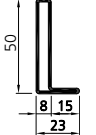
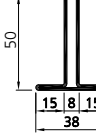
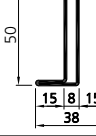
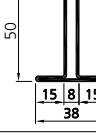
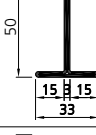
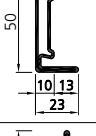
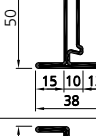
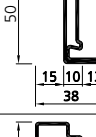
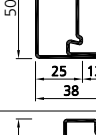
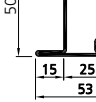
Profile / Profils / Profiles (1:4)	Art. Nr. art. no.	m	L [mm]	G [kg/m]	I _y [cm ⁴]	W _y [cm ³]	I _z [cm ⁴]	W _z [cm ³]	e _y [mm]	e _z [mm]	O [m ² /m]
	36.511	blank brut bright	6000	1.612	5.76	1.92	0.69	0.41	20.04	6.43	0.142
	36.512	blank brut bright	6000	1.958	7.01	2.11	1.45	0.77	16.76	19.00	0.172
	36.513	blank brut bright	6000	1.958	8.71	3.48	1.45	0.76	25.00	19.00	0.172
	36.515	blank brut bright	6000	2.301	10.77	3.78	2.01	0.97	21.49	20.70	0.201
	36.502	blank brut bright	6000	1.835	6.01	1.78	0.86	0.52	16.27	16.50	0.174
	37.511	blank brut bright	6000	1.800	6.01	1.93	0.73	0.43	18.90	6.08	0.158
	37.512	blank brut bright	6000	2.146	7.14	2.10	1.48	0.77	16.10	18.92	0.188
	37.513	blank brut bright	6000	2.145	9.22	3.50	1.48	0.77	23.62	18.92	0.187
	37.521	blank brut bright	6000	3.145	8.77	2.91	3.30	1.44	19.89	15.10	0.188
	37.522*	blank brut bright	6000	2.49	10.4	3.08	5.28	1.96	17.37	26.99	0.218

* auf Anfrage / sur demande / on request

**Profile
Stahl**

**Profilsés
Acier**

**Profiles
Steel**

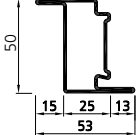
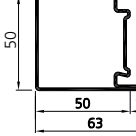
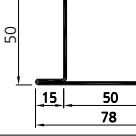
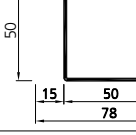
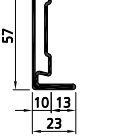
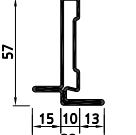
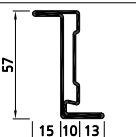
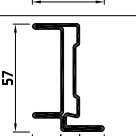
Profile / Profilsés / Profiles (1:4)	Art. Nr. art. no.	m	L [mm]	G [kg/m]	I _y [cm ⁴]	W _y [cm ³]	I _z [cm ⁴]	W _z [cm ³]	e _y [mm]	e _z [mm]	O [m ² /m]
	37.523*	blank brut bright	6000	2.506	11.92	4.55	5.31	1.97	23.81	26.99	0.218
	37.551*	blank brut bright	6000	2.751	13.39	4.62	14.60	4.32	20.99	29.21	0.238
	37.552	blank brut bright	6000	3.079	14.80	4.74	19.82	4.94	18.80	40.15	0.268
	37.553	blank brut bright	6000	3.082	16.29	6.28	19.84	4.94	24.05	40.13	0.268
	37.611	blank brut bright	6000	1.97	9.14	2.65	0.77	0.46	22.54	6.27	0.173
	37.612	blank brut bright	6000	2.312	9.88	2.70	1.54	0.80	20.47	19.25	0.202
	37.613	blank brut bright	6000	2.327	13.25	4.48	1.54	0.80	27.41	19.23	0.202
	37.615	blank brut bright	6000	2.658	14.59	4.56	2.13	1.05	25.03	17.74	0.231

* auf Anfrage / sur demande / on request

Systemübersicht

Tableau du système

Synopsis of system

901350 15
901351 20
901352 25
901353 30
901354 35
901202 15
901203 19
906580

901360 15
901361 15
901364 15
901363 20
906423

985392 **985394** **985395** **985396** **985397**
988002 4mm
988003 5mm
988004 6mm
988006 8mm
915754
980101
916337 **916338**

903204 19
905201 (EPDM)
963301 10.5 18
905900 17
905904 23.7
905905 30.3
905902 37

907662 (15mm) **907667** (15mm) **917682** (12 mm) **917014**

917306 (CrNi)
917308 (Alu)
917311 (CrNi)
917312 (Alu)
917307 (CrNi)
917309 (Alu)
917313* (CrNi) **907337** (CrNi)
917314* (CrNi) **907335** (CrNi)

* auf Anfrage
sur demande
on request

Systemschnitte

Coupes du système

System sections

LD = Lichter Durchgang
 passage libre
 clear passage

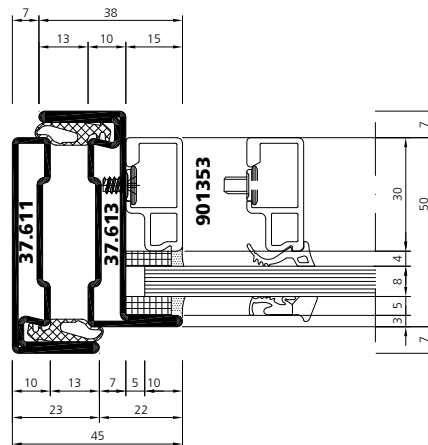
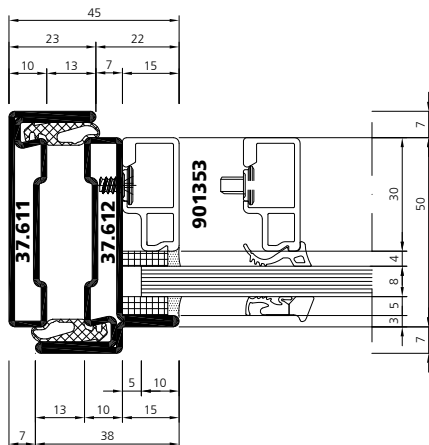
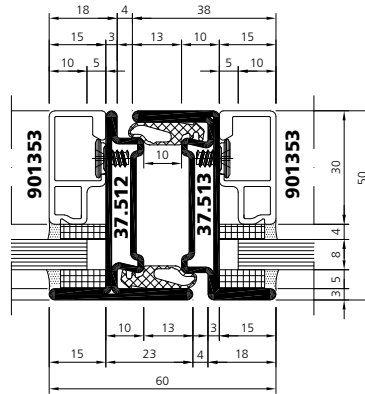
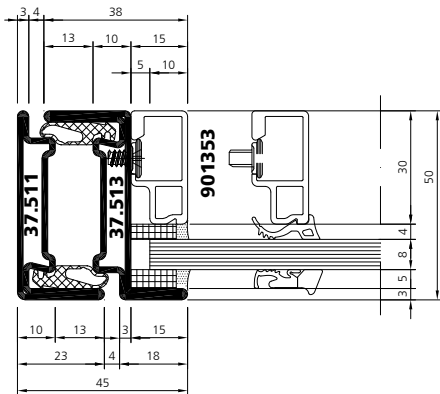
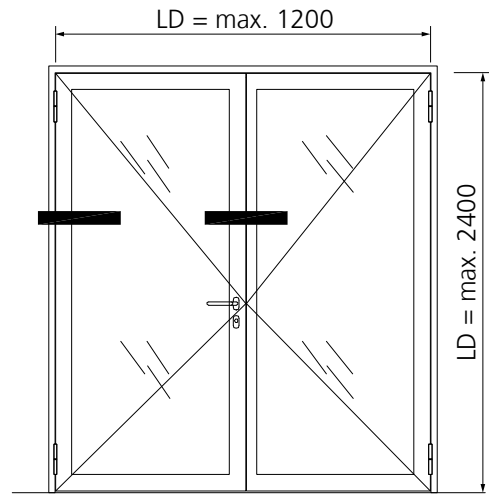
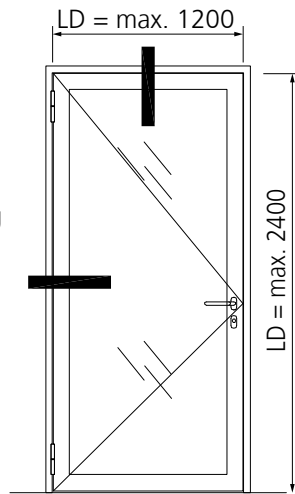

Schlosskasten
Dornmass 35

Boîtier de serrure
Distance au canon 35

Lock case
Backset 35

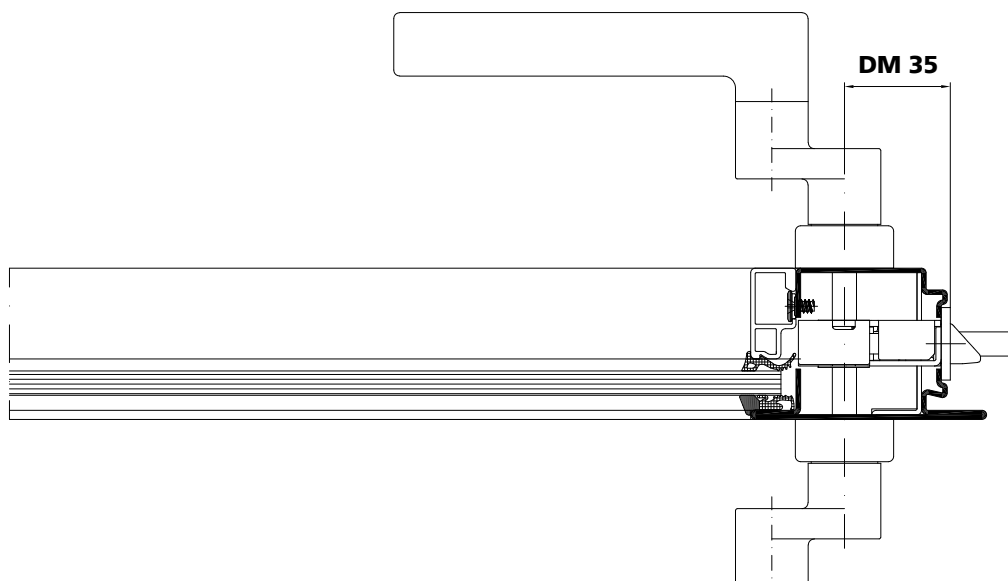
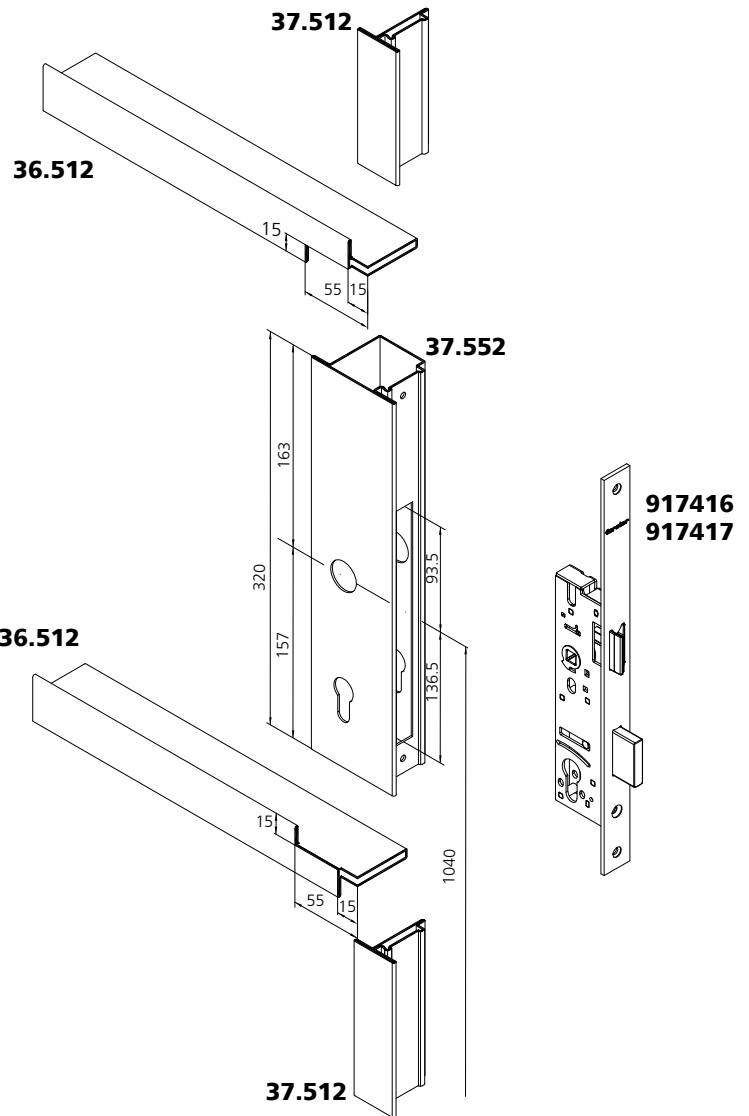
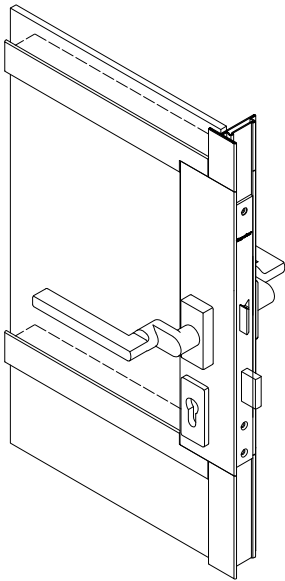

Schlosskasten
Dornmass 65

Boîtier de serrure
Distance au canon 65

Lock case
Backset 65

